

**TYPICAL PLAN NOTES**

SEE THE TYPICAL DETAILS FOR MORE INFORMATION.

**BURIED PLANT**

1. BORE DIAMETER FOR BIDDING PURPOSES SHALL BE 4" MIN FOR (3) 1 1/4"  $\phi$ , (2) 4 WAY 16/13 MULTI-DUCTS, (1) 7 WAY 18/14 MULTI-DUCT, OR SMALLER CONDUITS. BORE DIAMETER TO BE 5" MIN FOR (4) 1 1/4"  $\phi$  CONDUITS, (1) 4 WAY 18/14 + (1) 7 WAY 18/14 MULTI-DUCTS, (2) 7 WAY 16/13 MULTI-DUCTS, OR A SINGLE 4" CONDUIT, UNLESS NOTED ON THE PLANS. SEE THE PLANS FOR ALL OTHER LARGER SIZED BORE DIAMETERS AND LOCATIONS.
2. TYPICAL TRENCH DEPTHS:
  - A. ALL TRENCH DEPTHS ARE THE MINIMUM REQUIRED FROM FINAL FINISH GRADE TO TOP OF CONDUIT.
    - I. RESIDENTIAL AND CITY ROW 36".
    - II. COUNTY ROW 40".
    - III. STATE HIGHWAY ROW, 40" TO 60" AS INDICTED IN THE TYPICAL DETAILS.
    - VI. MICRO-TRENCH 16" DEEP GROSS, 15" DEEP x 1.5" OR 2" WIDE NET.
3. ALL NEW CONDUIT AND FIBER FACILITIES TO BE PLACED A MINIMUM OF 5'-0" HORIZONTAL AND 1'-0" VERTICAL FROM EXISTING CITY WATER, IRRIGATION, STORM DRAIN, AND SANITARY SEWER FACILITIES.
4. RUNNING LINE AND ALIGNMENT IN PAVEMENT SECTIONS TO BE MARKED BY THE CONTRACTOR AND REVIEWED FOR APPROVAL BY LEHI CITY PRIOR TO CUTTING PAVEMENT OR OPENING TRENCH.
5. WHEN TRENCHING, BORING, MICRO TRENCHING, OR PLACING NEW FIBER FACILITIES ALONG SIDE OR NEXT TO EXISTING UNDERGROUND POWER FACILITIES PROVIDE A MINIMUM OF 2'-0" HORIZONTAL AND 1'-0" VERTICAL SEPARATION.
6. CROSSINGS AT EXISTING UNDERGROUND CITY UTILITIES TO BE VISUALLY LOCATED INCLUDING FACILITIES UNDERNEATH ASPHALT AND CONCRETE PAVEMENT SECTIONS.
7. ALL PEDESTALS AND VAULTS TO BE PLACED A MINIMUM OF 4'-0" CLEAR OF POWER POLES AND FIRE HYDRANTS.
8. CONDUIT RUNS TO MAINTAIN 4'-0" MINIMUM FROM POWER POLE RUNNING LINE.
9. NOTIFY THE ENGINEER IF MINIMUM CLEARANCES TO POWER POLES OR POWER RUNNING LINES ARE NOT ABLE TO BE MET.
10. ALL CONDUITS PLACED IN AN OPEN TRENCH TO BE LOCATED SUCH THAT THEY MINIMIZE SNAKING AND MAINTAIN AS STRAIGHT A PROFILE AS POSSIBLE.
11. FIBER MARKER POSTS TO BE PLACED IN GENERAL AREAS WHERE FUTURE UNDER GROUND CONSTRUCTION MAY OCCUR. FINAL FIBER MARKER POSTS LOCATIONS TO BE DETERMINED BY THE STRATA NETWORKS FIELD INSPECTOR.
12. ALL CONDUIT PATHWAYS SHALL BE PROOFED FOR FUTURE CABLE INSTALLATION PRIOR TO THE COMPLETION OF CONSTRUCTION.
13. ALL INSTALLED TRACER LOCATE WIRE PATHWAYS SHALL BE VERIFIED FOR CONTINUITY, DIRECTION, AND PROPER GROUNDING PRIOR TO THE COMPLETION OF CONSTRUCTION.
14. ALL PEDESTALS ARE TO BE STENCILED AND ADDRESSED FOR RECORDS.
15. RE-SEEDING ALL TRENCHED AREAS IS REQUIRED WHEN REQUIRED BY THE LOCAL OR STATE JURISDICTION.

**AERIAL PLANT**

1. ALL MESSENGER WIRE, STRAND, AND FIBER PLACED ON LEHI POWER POLES MUST BE ATTACHED A MINIMUM OF 40" BELOW POWER LINES, NEUTRALS, WEATHER HEADS, TRANSFORMERS, AND DRIP LOOPS AT THE POLE LOCATION AND BE 30" MINIMUM BELOW POWER LINES AT MIDSPAN SAG LOCATIONS. SEE 2017 NESC TABLE 235-5 AND TABLE 238-1 FOR ADDITIONAL INFORMATION.
2. PROVIDE A RECORD OF ALL POLE NUMBER(S) FOR ALL JOINT USE POWER POLES, FOR ALL NEW AND EXISTING ATTACHMENTS THAT ARE NOT INDICATED IN THE DESIGN DOCUMENTS.
3. AERIAL MINIMUM HEIGHT REQUIREMENTS:
  - A. ALL AERIAL PLACEMENT MINIMUM REQUIRED HEIGHTS ARE FROM THE POLE ATTACHMENT LOCATION TO THE ADJACENT ROADWAY/TRAFFIC LANE/FINISH GRADE OR FROM THE MIDSPAN POINT AT WHICH A ROAD/TRAFFIC CROSSING/FINISH GRADE OCCURS. SEE 2017 NESC SECTION 23 TABLE 232-1.
    - I. STATE HIGHWAY CROSSING, 21'-0" (UDOT).
    - II. COUNTY ROAD CROSSING, 15'-6".
    - III. CITY ROAD CROSSING, 15'-6".
    - IV. COMMERCIAL/INDUSTRIAL DRIVEWAY CROSSING, 15'-6".
    - V. RESIDENTIAL DRIVEWAY CROSSING/ALLEY CROSSING, 15'-6".
    - VI. RURAL/RESIDENTIAL NO TRAFFIC/DRIVEWAY CROSSING, 15'-6".
    - VII. RESIDENTIAL/COMMERCIAL DROPS, NON VEHICULAR TRAFFIC AREAS, 10'-0" (2017 NESC 9'-6").
  - B. VERTICAL MINIMUM CLEARANCE FOR ALL TELCO, FIBER, AND CATV CABLES SHALL BE 3'-6" ABOVE ALL SHEDS, BUILDING ROOFS, BALCONIES, FREE STANDING SIGNS, AND OTHER SIMILAR TYPE STRUCTURES.
  - C. WHEN POWER AND TELCO/FIBER/CATV DROPS STEM FROM THE SAME DROP POLE AND ATTACH TO THE BUILDING NEAR EACH OTHER THE MINIMUM CLEARANCES OF 12" VERTICAL AND 0" HORIZONTAL MAY BE USED, OTHERWISE CLEARANCES PER 2017 NESC 235.C.1. AND TABLE 235-2 MUST BE FOLLOWED.
4. POLE ANCHORS TO MAINTAIN 1'-0" MINIMUM DISTANCE FROM EXISTING POWER ANCHORS. COMBINED USE ANCHORS ARE NOT PERMITTED. ADD NEW ANCHORS WHERE JOINT USE ANCHORS ARE LOCATED. PROVIDE A JOHNNY BALL AT EACH ANCHOR/DOWN GUY LOCATION.
5. PROVIDE GROUNDING FOR ALL AERIAL MESSENGER WIRE/STRAND AND CABLE AT 1/4 MILE MAX INTERVALS AND AT ALL CABLE AERIAL SPLICE LOCATIONS.
6. NOTIFY ENGINEER IMMEDIATELY IF MINIMUM CLEARANCES ARE NOT ABLE TO BE MET.
7. ALL AERIAL PLANT SHALL BE INSTALLED IN ACCORDANCE WITH THE 2017 NESC CODE.



**NOTES:**

1. PLACE HAND-HOLE AGAINST R.O.W. LINE UNLESS NOTED OTHERWISE (U.N.O.) ON THE PLANS. SWEEP DUCTS AND TRACER LOCATE WIRE INTO HAND-HOLE WHILE MAINTAINING A 4' MIN. RADIUS AT ALL CONDUIT BENDS. PLUG OR CAP ALL CONDUIT ENDS FOR CONDUITS NOT IN USE. TAPE ALL CONDUIT ENDS THAT CONTAIN CABLE/FIBER.
2. FIBER MARKER POSTS LOCATIONS TO BE DETERMINED BY THE STRATA NETWORKS FIELD INSPECTOR. FOR BIDDING PURPOSES MARKER POSTS MAY ASSUMED TO BE PLACED AT MAJOR IRRIGATION, DRAINAGE, BURIED GAS, AND MAJOR UTILITY CROSSINGS.
3. DETAIL IS REPRESENTATIVE OF TYPICAL FIELD CONDITIONS. ACTUAL CONDITIONS MAY VARY AND ARE SUSCEPTIBLE TO ALTERATIONS AS WARRANTED BY STRATA NETWORKS FIELD INSPECTORS.

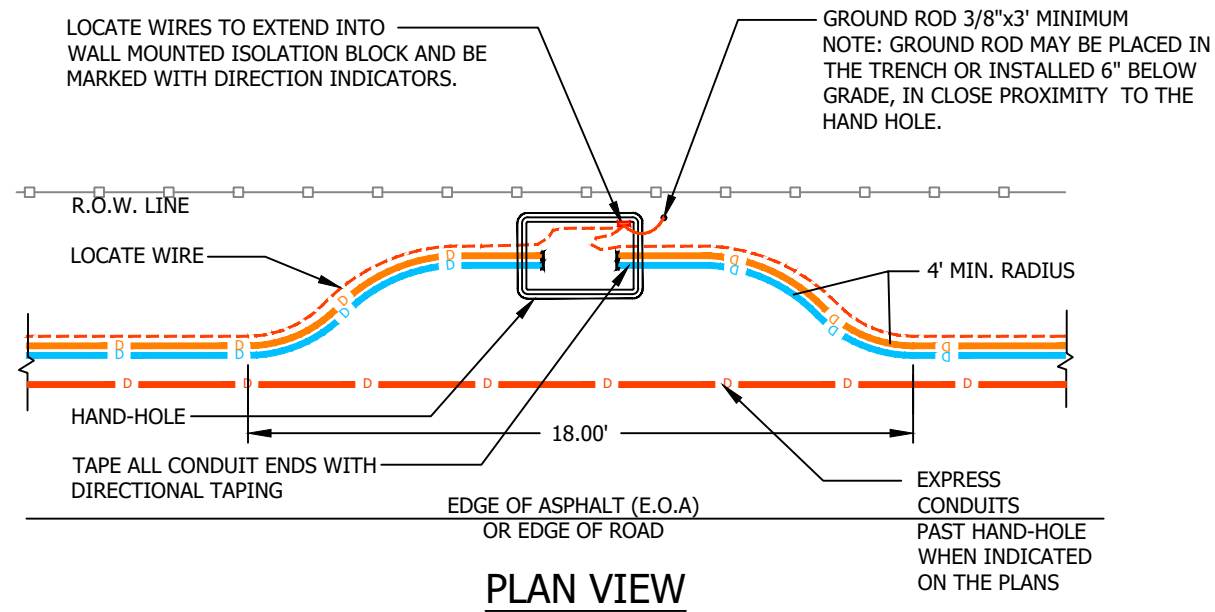

**PLAN VIEW**

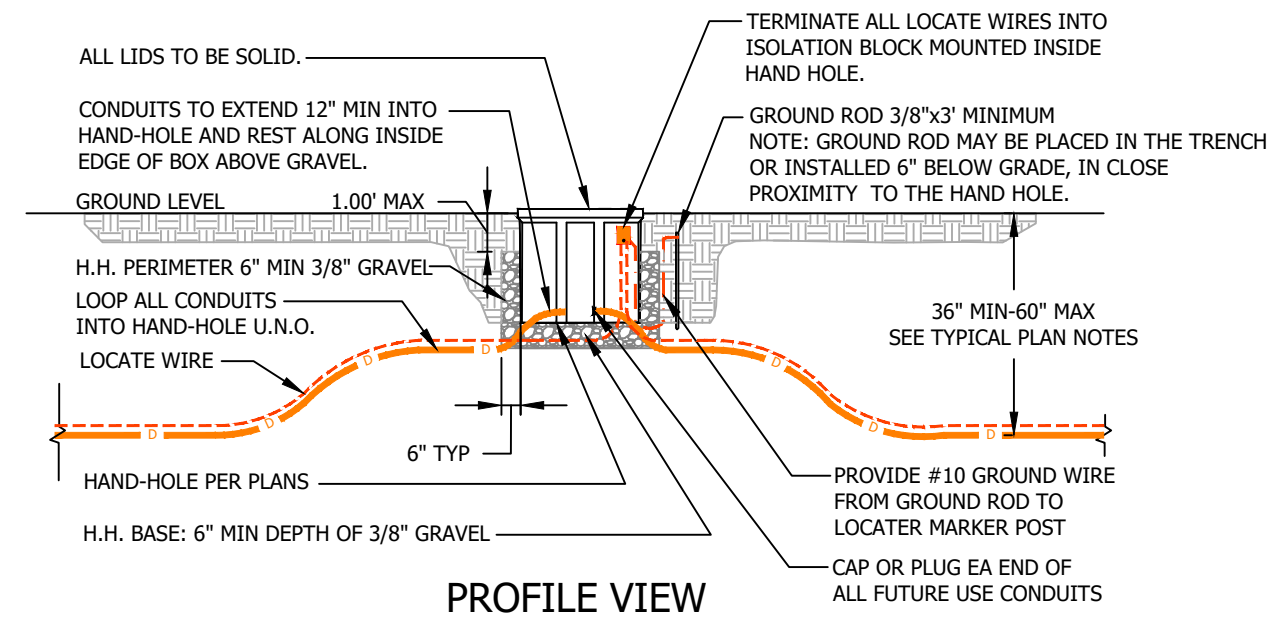

**PROFILE VIEW**

**PREFERRED HAND-HOLE PLACEMENT DETAIL**

**NOTES:**

1. PLACE HAND-HOLE AGAINST R.O.W. LINE UNLESS NOTED OTHERWISE (U.N.O.) ON THE PLANS. SWEEP DUCTS AND TRACER LOCATE WIRE INTO HAND-HOLE WHILE MAINTAINING A 4' MIN. RADIUS AT ALL CONDUIT BENDS. PLUG OR CAP ALL CONDUIT ENDS FOR CONDUITS NOT IN USE. TAPE ALL CONDUIT ENDS THAT CONTAIN CABLE/FIBER.
2. FIBER MARKER POSTS LOCATIONS TO BE DETERMINED BY THE STRATA NETWORKS FIELD INSPECTOR. FOR BIDDING PURPOSES MARKER POSTS MAY ASSUMED TO BE PLACED AT MAJOR IRRIGATION, DRAINAGE, BURIED GAS, AND MAJOR UTILITY CROSSINGS.
3. DETAIL IS REPRESENTATIVE OF TYPICAL FIELD CONDITIONS. ACTUAL CONDITIONS MAY VARY AND ARE SUSCEPTIBLE TO ALTERATIONS AS WARRANTED BY STRATA NETWORKS FIELD INSPECTORS.

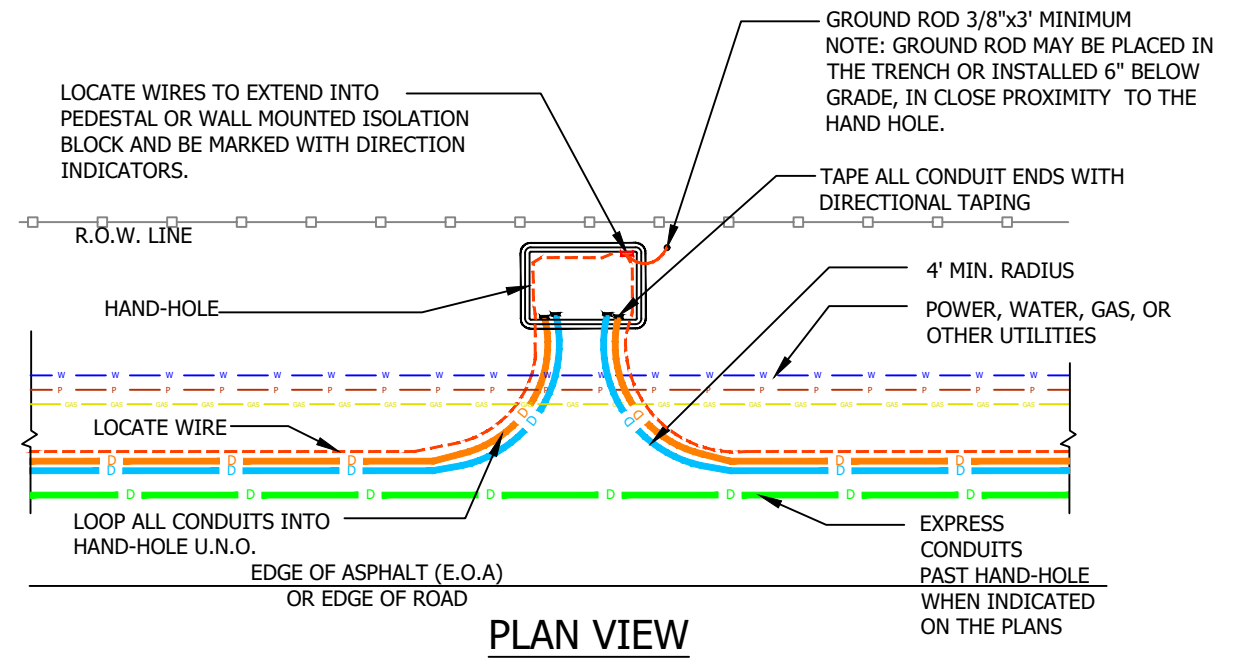

**PLAN VIEW**

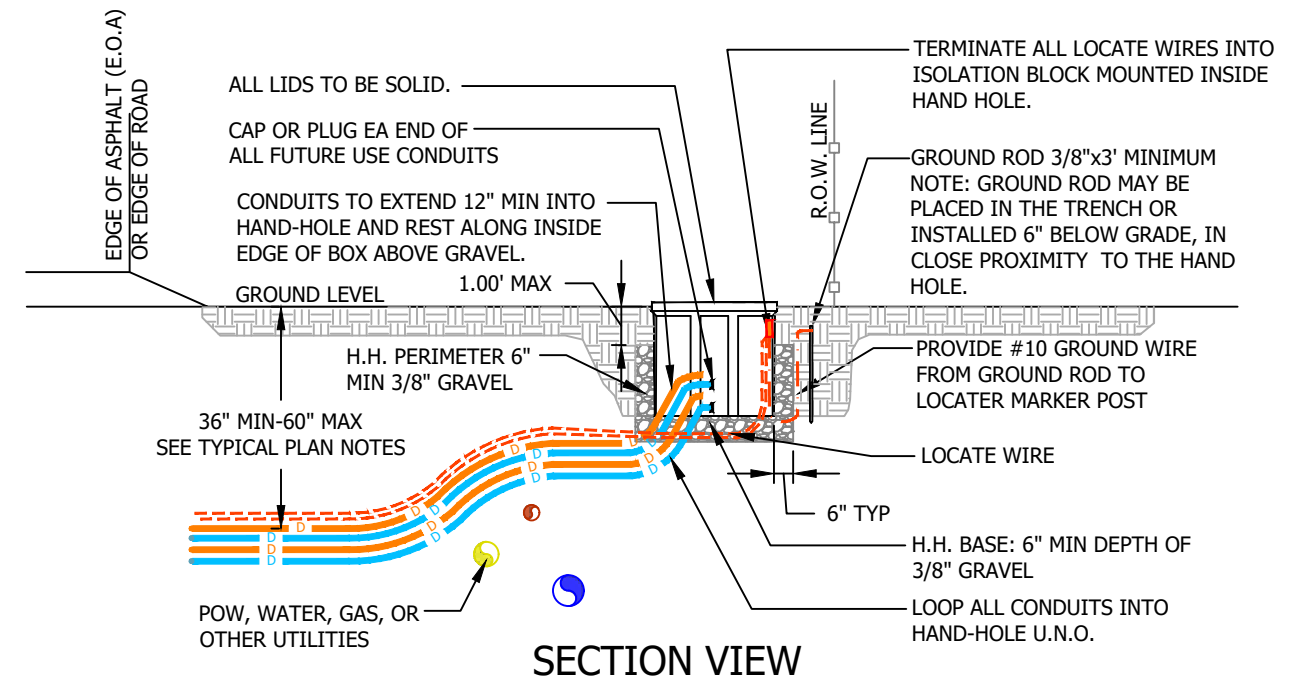

**SECTION VIEW**

**ALTERNATE HAND-HOLE PLACEMENT DETAIL**

**NOTES:**

1. PLACE PEDESTAL AGAINST R.O.W. LINE UNLESS NOTED OTHERWISE (U.N.O.) ON THE PLANS. LOOP ALL DUCTS INTO PEDESTAL WHILE MAINTAINING A RADIUS/SWEEP AT ALL BENDS. PLUG OR CAP ALL CONDUIT ENDS FOR CONDUITS NOT IN USE. PLUG/TAPE ALL CONDUIT ENDS THAT CONTAIN CABLE/FIBER.
2. CONDUITS PLACED FROM PEDESTALS TO HAND-HOLES CONTAINING A FUTURE MST FIBER SHALL NOT BE LONGER THAN 680' IN LINEAR LENGTH. THE MAXIMUM MST DESIGN LENGTH SHALL BE 750'.
3. DETAIL IS REPRESENTATIVE OF TYPICAL FIELD CONDITIONS. ACTUAL CONDITIONS MAY VARY AND ARE SUSCEPTIBLE TO ALTERATIONS AS WARRANTED BY STRATA NETWORKS FIELD INSPECTORS.
4. SWEEP DUCTS AND LOCATE WIRE INTO HAND-HOLE WHILE MAINTAINING MIN. BENDING RADIUS AT ALL CONDUIT BENDS.  
 MIN. BEND RADIUSES: 18/14 MICRO-DUCT= 7", 16/13 MICR-DUCT= 6"  
 1-1/4" AND MULTI-WAY FUTURE PATH MICRO-CONDUITS = 4'

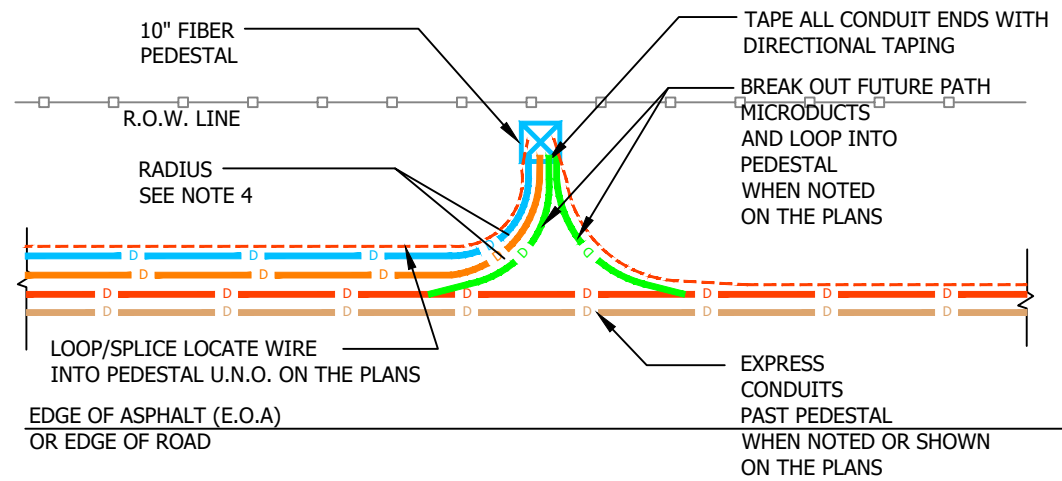

**PLAN VIEW**

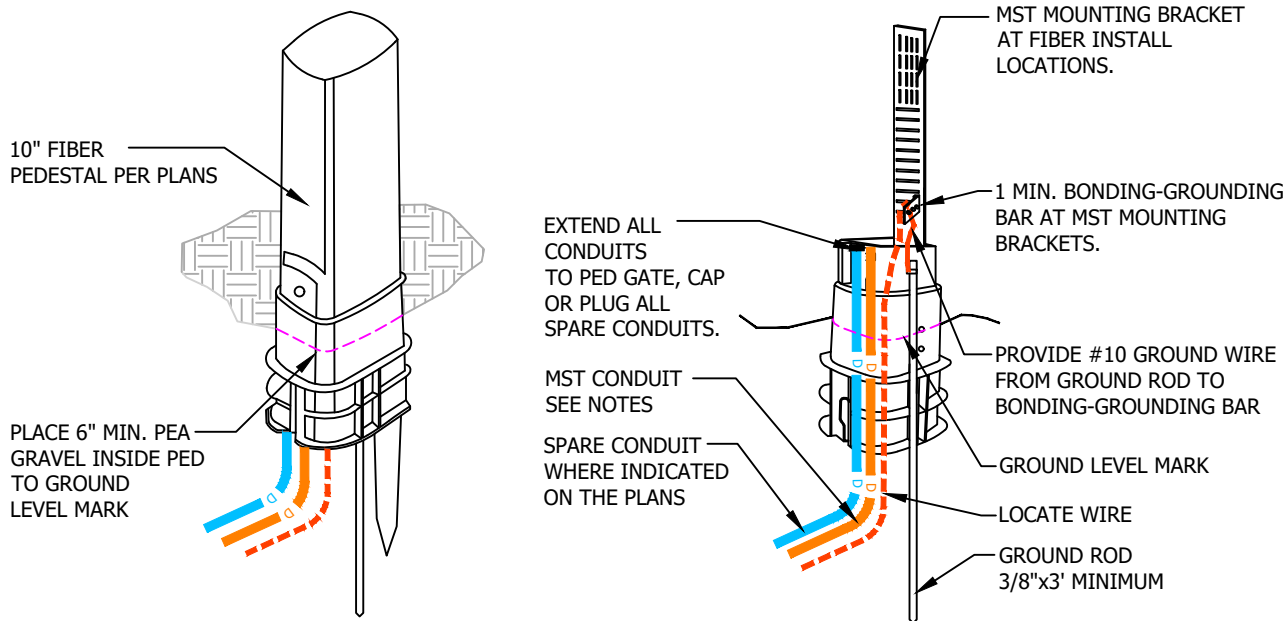

**PROFILE VIEW**

**PEDESTAL PLACEMENT DETAIL**

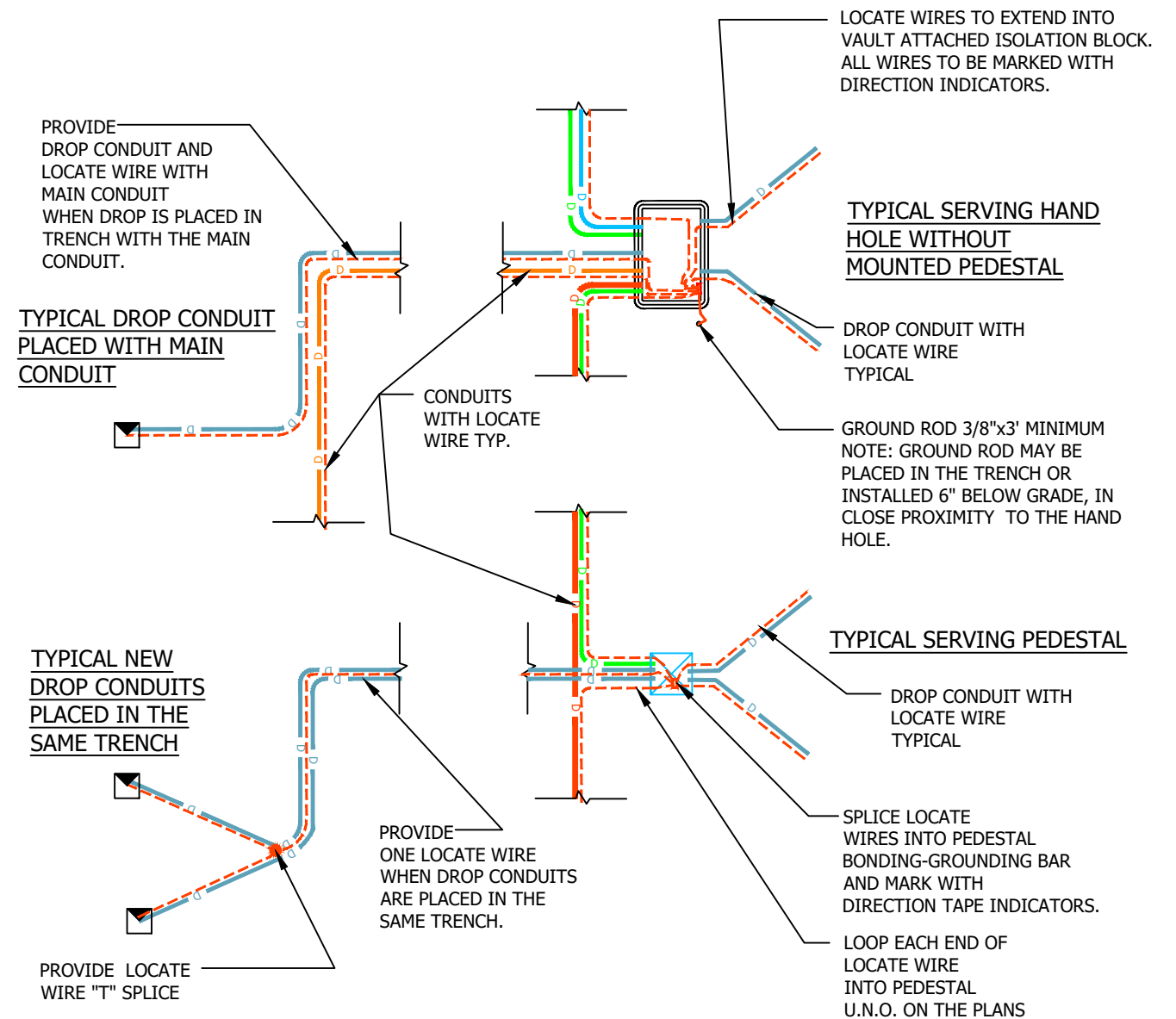

**TYPICAL LOCATE SYSTEM DETAIL**

**NOTES:**

1. PLACE HAND-HOLE AGAINST R.O.W. LINE WHERE POSSIBLE. HAND-HOLE MAY BE PLACED AT THE T.B.C. OR OUTSIDE EDGE OF SIDE WALK AS NEEDED. SWEEP ALL CONDUITS AND TRACER LOCATE WIRE INTO HAND-HOLE WHILE MAINTAINING MIN. RADIUSSES AT ALL CONDUIT BENDS. PLUG OR CAP ALL CONDUIT ENDS FOR CONDUITS NOT IN USE. TAPE ALL CONDUIT ENDS THAT CONTAIN CABLE/FIBER.
2. FIBER MARKER POSTS LOCATIONS TO BE DETERMINED BY THE STRATA NETWORKS FIELD INSPECTOR. FOR BIDDING PURPOSES MARKER POSTS MAY ASSUMED TO BE PLACED AT MAJOR IRRIGATION, DRAINAGE, BURIED GAS, AND MAJOR UTILITY CROSSINGS.
3. DETAIL IS REPRESENTATIVE OF TYPICAL FIELD CONDITIONS. ACTUAL CONDITIONS MAY VARY AND ARE SUSCEPTIBLE TO ALTERATIONS AS WARRANTED BY STRATA NETWORKS FIELD INSPECTORS.

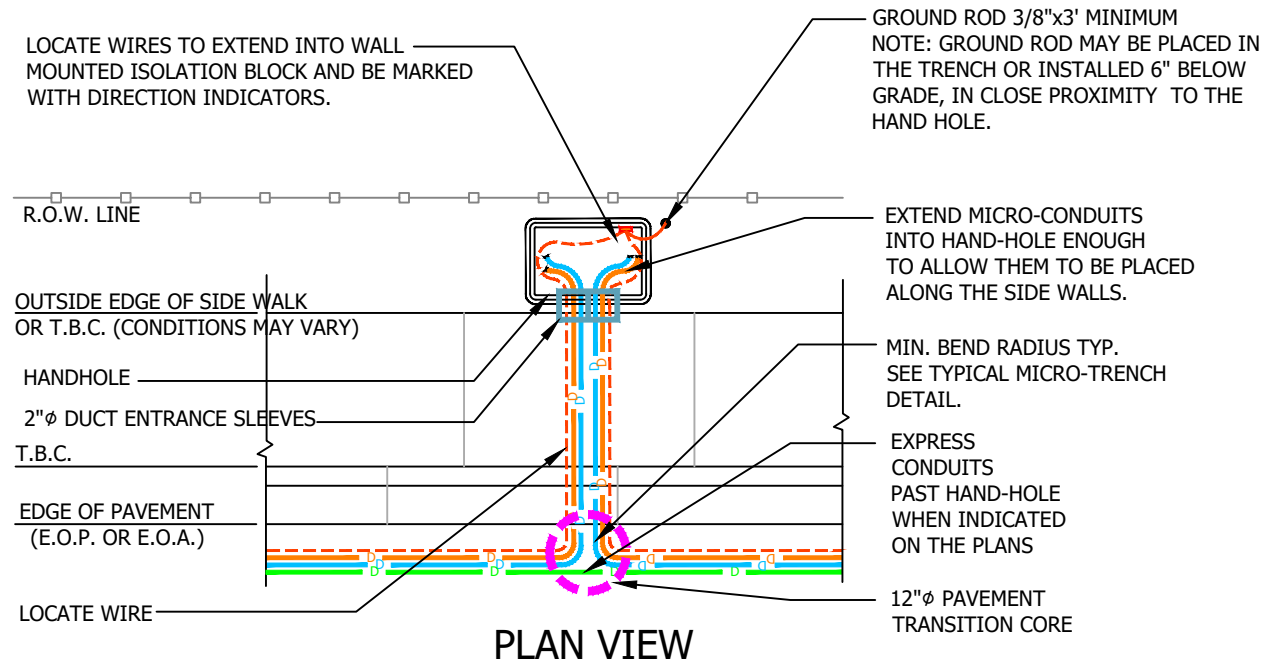

**PLAN VIEW**

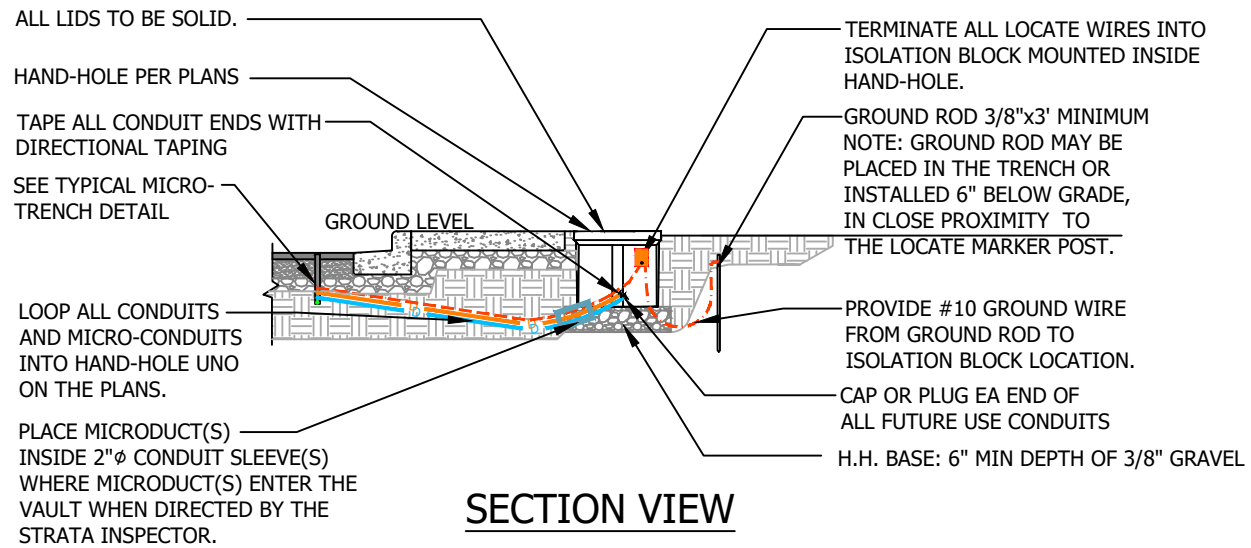

**SECTION VIEW**

**MICRO-TRENCH HAND-HOLE PLACEMENT DETAIL**

**NOTES:**

1. PLACE ACCESS TERMINAL (HAND-HOLE, PEDESTAL, ETC.) AGAINST R.O.W. LINE WHERE POSSIBLE. ACCESS TERMINAL WILL BE PLACED OUTSIDE PLANNED T.B.C., SIDEWALK, OR OTHER FUTURE IMPROVEMENTS. SWEEP ALL CONDUITS AND LOCATE WIRE INTO ACCESS TERMINAL WHILE MAINTAINING MIN. RADIUSSES AT ALL CONDUIT BENDS. PLUG OR CAP ALL CONDUIT ENDS FOR CONDUITS NOT IN USE. TAPE ALL CONDUIT ENDS THAT CONTAIN CABLE/FIBER.
2. FIBER MARKER POSTS LOCATIONS TO BE DETERMINED BY THE STRATA NETWORKS FIELD INSPECTOR. FOR BIDDING PURPOSES MARKER POSTS MAY ASSUMED TO BE PLACED AT MAJOR IRRIGATION, DRAINAGE, BURIED GAS, AND MAJOR UTILITY CROSSINGS.
3. DETAIL IS REPRESENTATIVE OF TYPICAL FIELD CONDITIONS. ACTUAL CONDITIONS MAY VARY AND ARE SUSCEPTIBLE TO ALTERATIONS AS WARRANTED BY STRATA NETWORKS FIELD INSPECTORS.
4. THIS DETAIL IS ONLY APPLICABLE TO DISTANCES GREATER THAN 12' BETWEEN E.O.P. AND EDGE OF ACCESS TERMINAL PLACEMENT AND WHERE NO C&G OR SIDEWALK IS PRESENT. FOR LOCATIONS WITH EXISTING C&G, SIDEWALK, AND DISTANCES LESS THAN 12' SEE THE TYPICAL MICRO-TRENCH HAND-HOLE OR PEDESTAL PLACEMENT DETAILS.

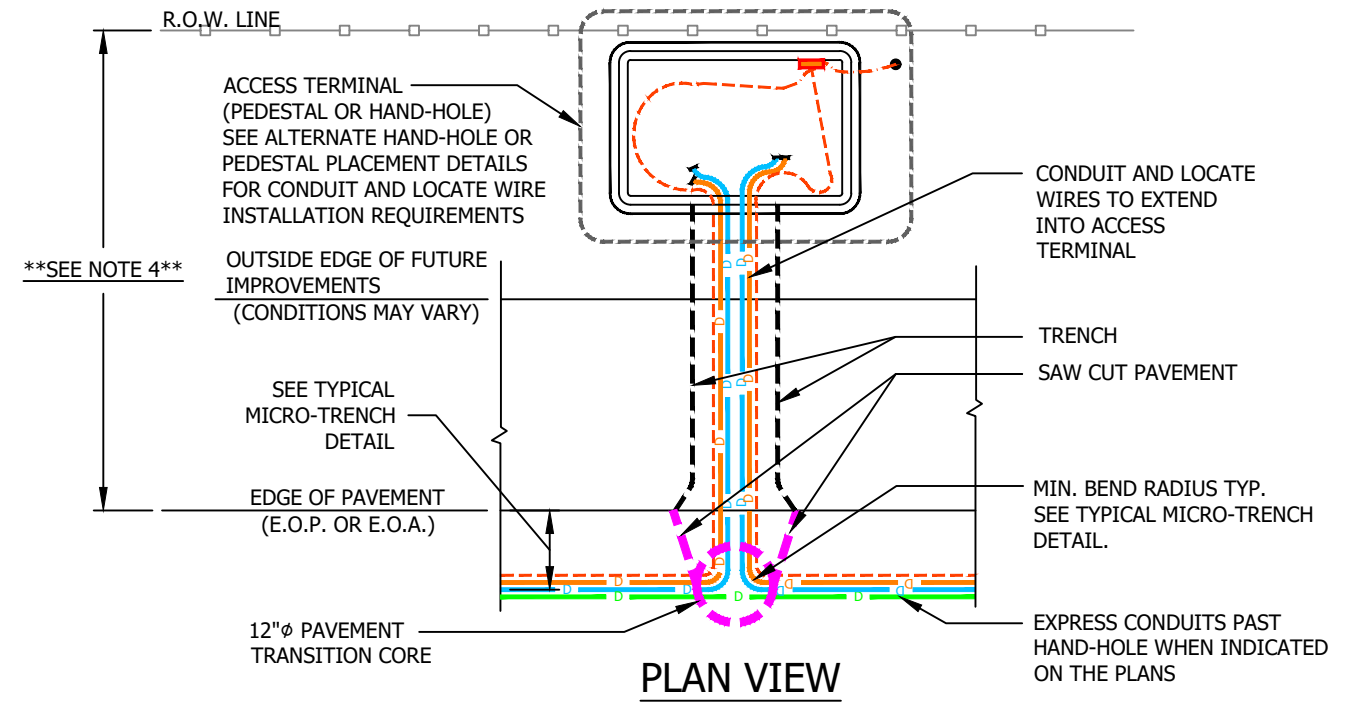

**PLAN VIEW**

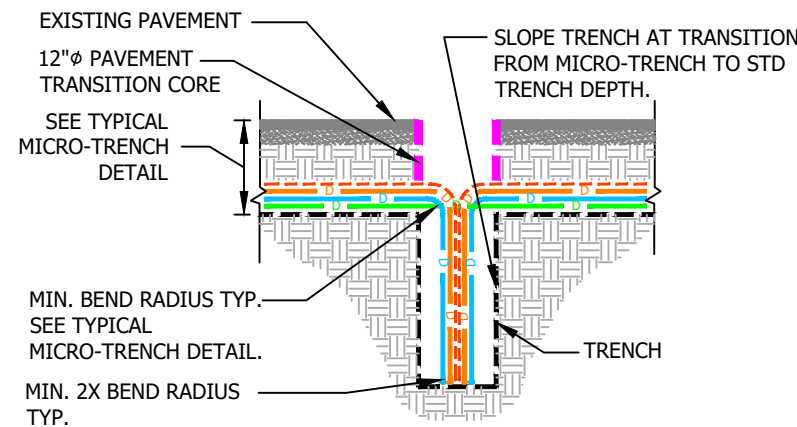

**PROFILE VIEW**

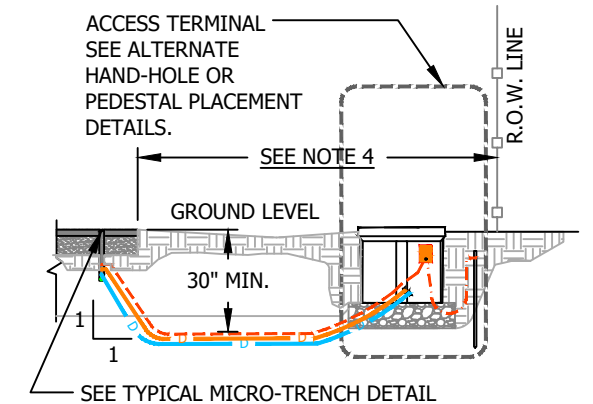

**SECTION VIEW**

**WIDE UNIMPROVED R.O.W MICRO-TRENCH ACCESS TERMINAL PLACEMENT DETAIL**

**NOTES:**

1. PLACE PEDESTAL AGAINST R.O.W. LINE UNLESS NOTED OTHERWISE (U.N.O.) ON THE PLANS. LOOP ALL DUCTS INTO PEDESTAL WHILE MAINTAINING A RADIUS/SWEEP AT ALL BENDS. PLUG OR CAP ALL CONDUIT ENDS FOR CONDUITS NOT IN USE. TAPE ALL CONDUIT ENDS THAT CONTAIN CABLE/FIBER.
2. CONDUITS PLACED FROM PEDESTALS TO HAND-HOLES CONTAINING A FUTURE MST FIBER SHALL NOT BE LONGER THAN 680' IN LINEAR LENGTH. THE MAXIMUM MST DESIGN LENGTH SHALL BE 750'.
3. DETAIL IS REPRESENTATIVE OF TYPICAL FIELD CONDITIONS. ACTUAL CONDITIONS MAY VARY AND ARE SUSCEPTIBLE TO ALTERATIONS AS WARRANTED BY STRATA NETWORKS FIELD INSPECTORS.
4. SWEEP DUCTS AND LOCATE WIRE INTO HAND-HOLE WHILE MAINTAINING MIN. BENDING RADIUS AT ALL CONDUIT BENDS.  
MIN. BEND RADIIUSES: 18/14 MICRO-DUCT= 7", 16/13-14/10 MICR-DUCT= 6" ,  
1-1/4" AND MULTI-WAY FUTURE PATH MICRO-CONDUITS = 4'

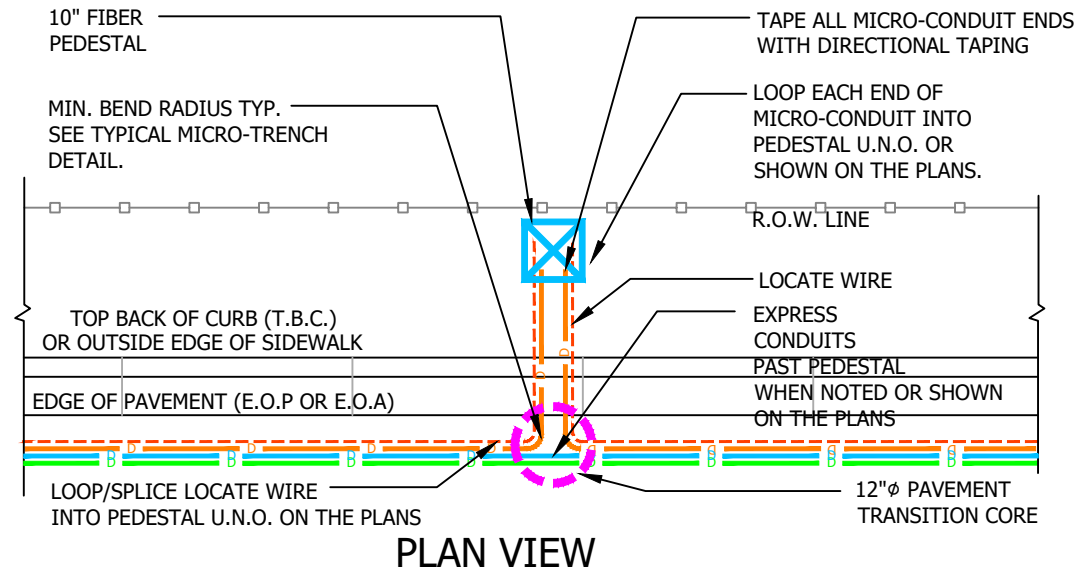

**PLAN VIEW**

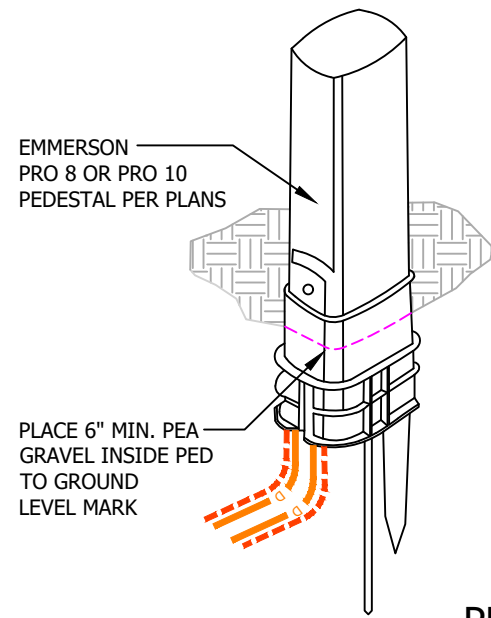

**PROFILE VIEW**

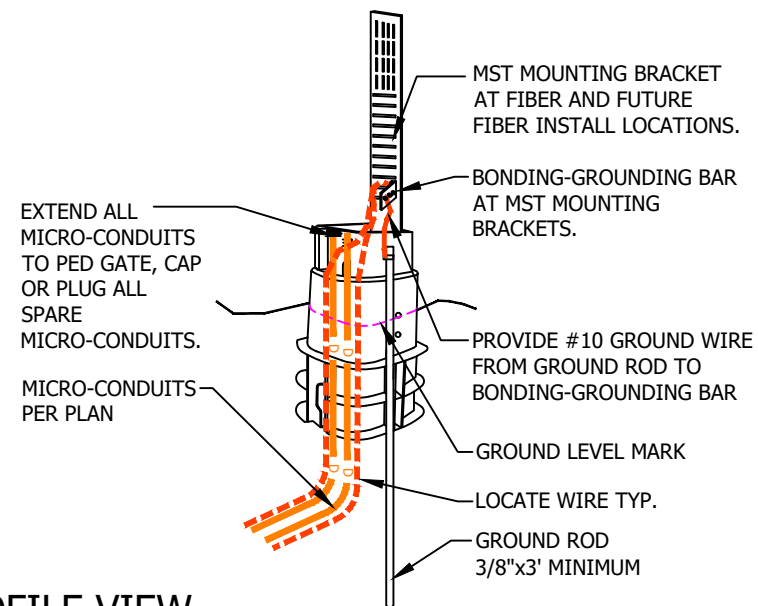

**PROFILE VIEW**

**MICRO-TRENCH PEDESTAL PLACEMENT DETAIL**

**NOTES:**

1. PLACE PULL BOX AGAINST R.O.W. LINE WHERE POSSIBLE. PULL BOX MAY BE PLACED AT 6" MIN. FROM T.B.C. OR OUTSIDE EDGE OF SIDE WALK AS NEEDED. PULL BOXES ARE NOT TO BE PLACED IN LOCATIONS WHERE POTENTIAL VEHICLE TRAFFIC MAY OCCUR. LOOP ALL UNUSED DROP MICRO-CONDUITS INTO PULL BOX WHILE MAINTAINING A RADIUS/SWEEP AT ALL BENDS. PLUG OR CAP ALL MICRO-CONDUIT ENDS INSIDE PULL BOX. ALL CONDUITS WITH LOCATE WIRE CONTAINING FIBER SHALL BYPASS THE PULL BOX. PULL BOX IS INTENDED TO BE REMOVED ONCE THE FUTURE DROP CONDUIT HAS BEEN INSTALLED.
2. MICRO-CONDUITS PLACED FROM PREMISE LOCATION CONTAINING A FIBER DROP SHALL NOT BE LONGER THAN 725' IN LINEAR LENGTH. THE MAXIMUM FIBER DROP DESIGN LENGTH SHALL BE 750'.
3. DETAIL IS REPRESENTATIVE OF TYPICAL FIELD CONDITIONS. ACTUAL CONDITIONS MAY VARY AND ARE SUSCEPTIBLE TO ALTERATIONS AS WARRANTED BY STRATA NETWORKS FIELD INSPECTORS.

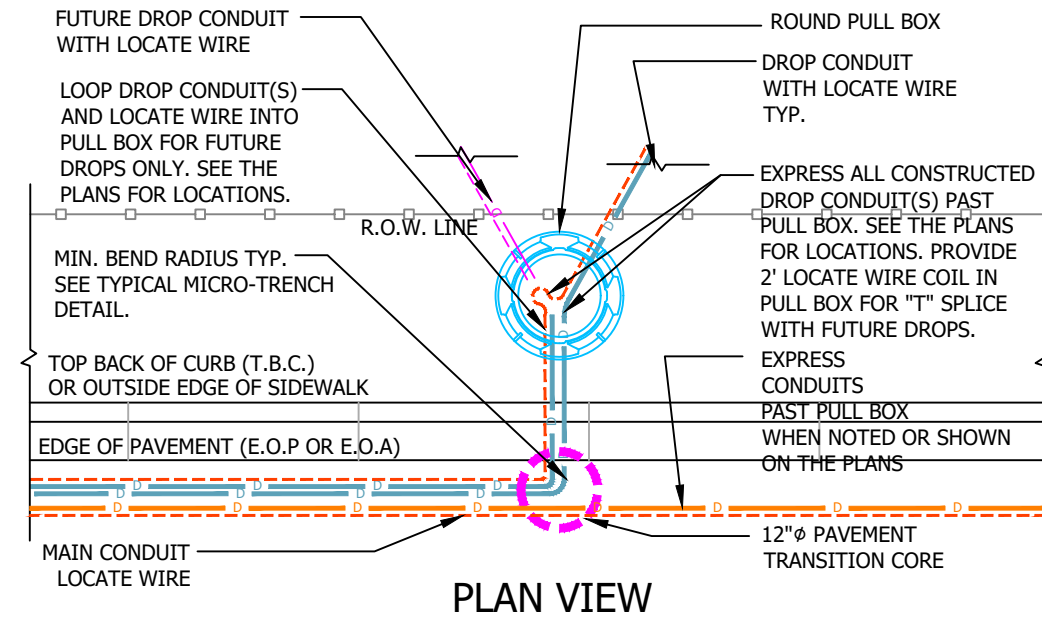

**PLAN VIEW**

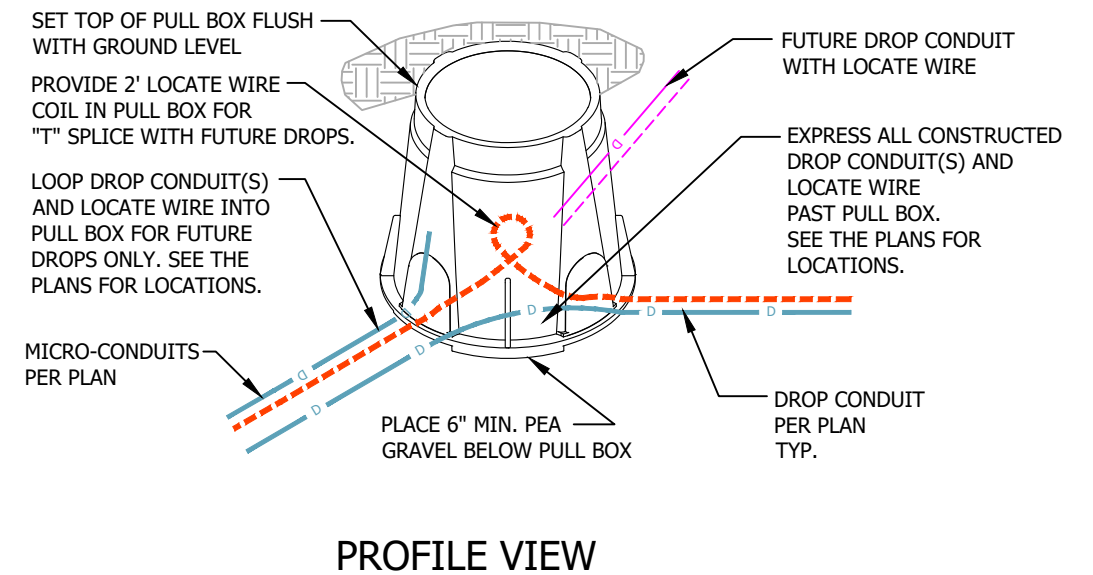

**MICRO-TRENCH PULL BOX PLACEMENT DETAIL**

**NOTES:**

1. MICRO-TRENCH LOCATION TO BE PLACED AS NOTED ON THE DRAWINGS. NOTIFY ENGINEER PRIOR TO CONSTRUCTION FOR ALTERATIONS TO MICRO-TRENCH LOCATIONS.
2. MICRO-CONDUIT MINIMUM BEND RADIUS ARE AS FOLLOWS:  
 18/14 MICRO-CONDUIT=7"  
 16/13 MICRO-CONDUIT=6"
3. MAXIMUM MICRO-CONDUITS PLACED INSIDE A 1.5" WIDE MICRO-TRENCH ARE AS FOLLOWS:  
 (6) 18/14 MICRO-CONDUITS  
 (7) 16/13 OR SMALLER MICRO-CONDUITS  
 (4) 18/14 + (3) 16/13 OR SMALLER MICRO-CONDUITS
4. MAXIMUM MICRO-CONDUITS PLACED INSIDE A 2" WIDE MICRO-TRENCH ARE AS FOLLOWS:  
 (8) 18/14 MICRO-CONDUITS  
 (10) 16/13 OR SMALLER MICRO-CONDUITS  
 (4) 18/14 + (5) 16/13 OR SMALLER MICRO-CONDUITS
5. ATTACH LOCATE WIRE TO TOP MICRO-CONDUIT WITH TAPE OR ZIP TIES AT 6'-0" MAX SPACING.

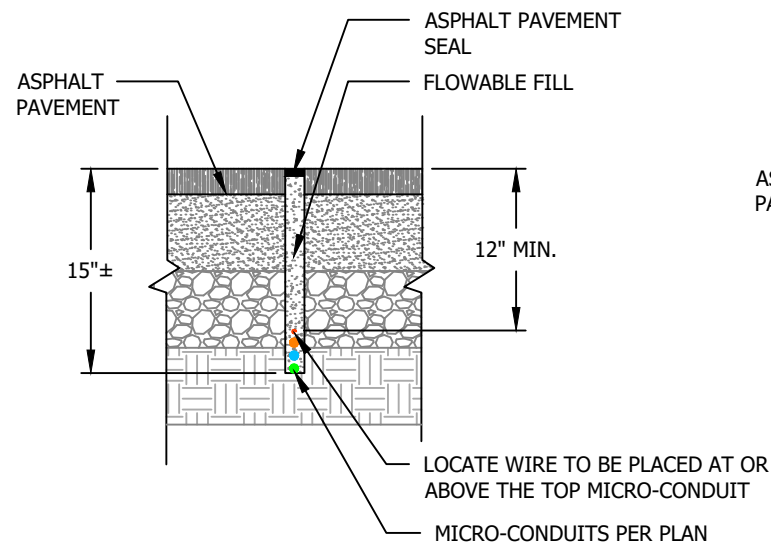

**TYPICAL PAVEMENT MICRO-TRENCH**

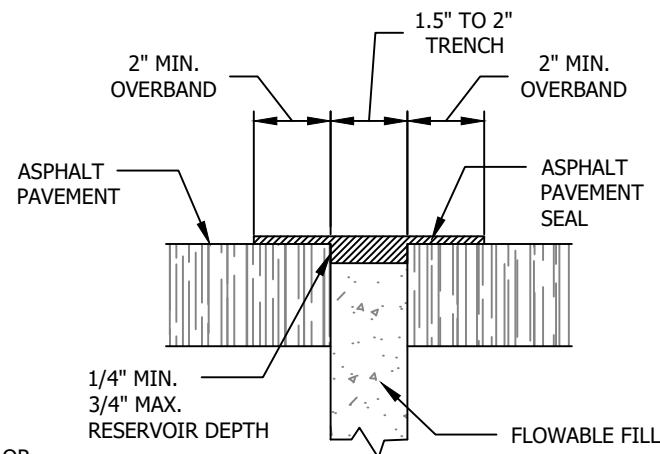

**TYPICAL PAVEMENT MICRO-TRENCH SEAL**

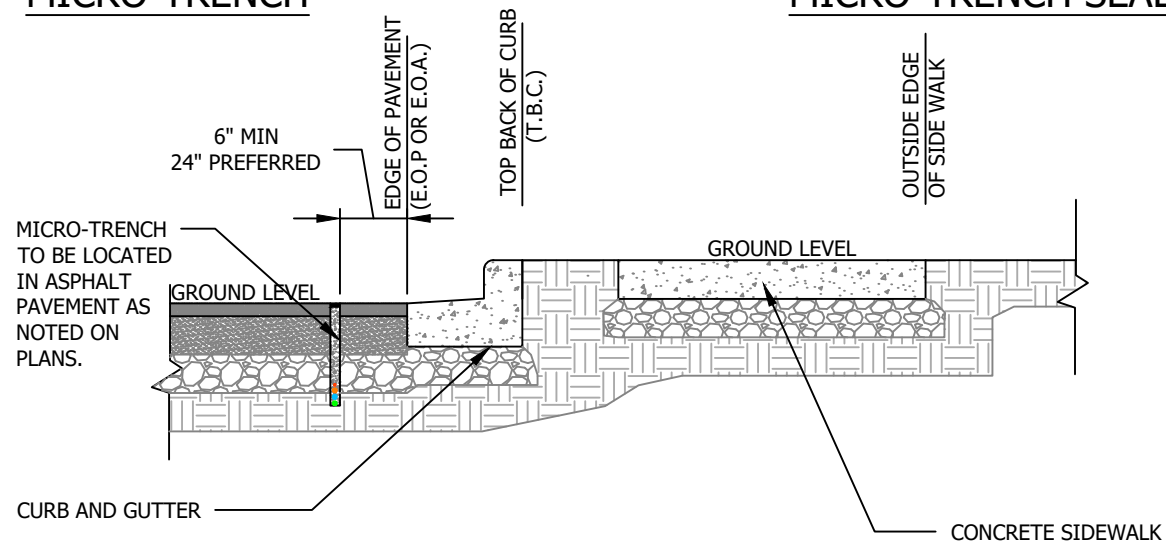

**TYPICAL MICRO-TRENCH DETAIL**

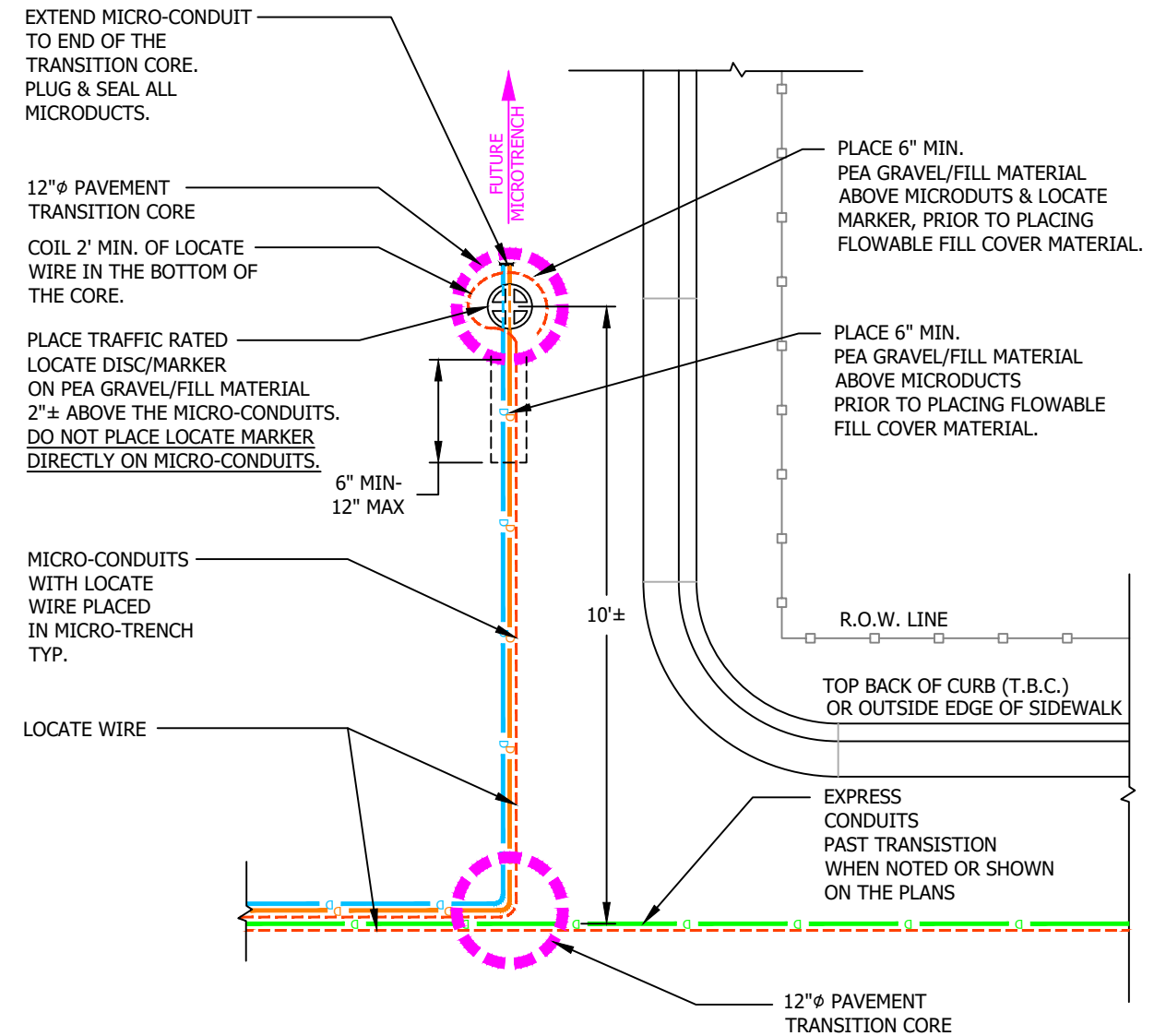

**MICRO-TRENCH TERMINATION DETAIL**

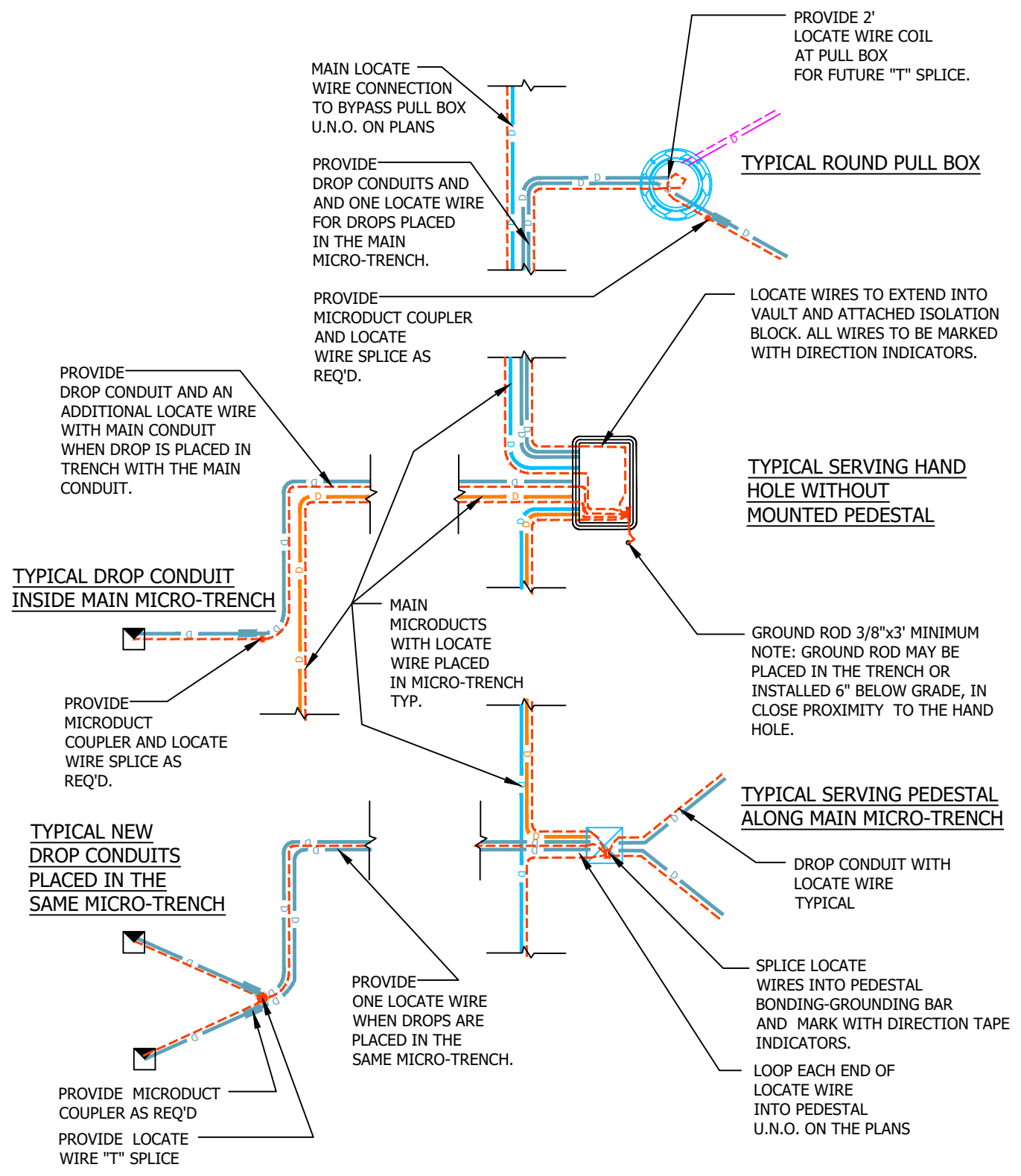

**MICRO-TRENCH LOCATE WIRE DETAIL**

- NOTES:**
1. LOCATE WIRE MAY BE LOCATED INSIDE OF AN EXISTING CONDUIT OR FASTENED TO THE EXTERIOR OF A NEW CONDUIT.
  2. DETAIL IS REPRESENTATIVE OF TYPICAL FIELD CONDITIONS. ACTUAL CONDITIONS MAY VARY AND ARE SUSCEPTIBLE TO ALTERATIONS AS WARRANTED BY STRATA NETWORKS FIELD INSPECTORS.

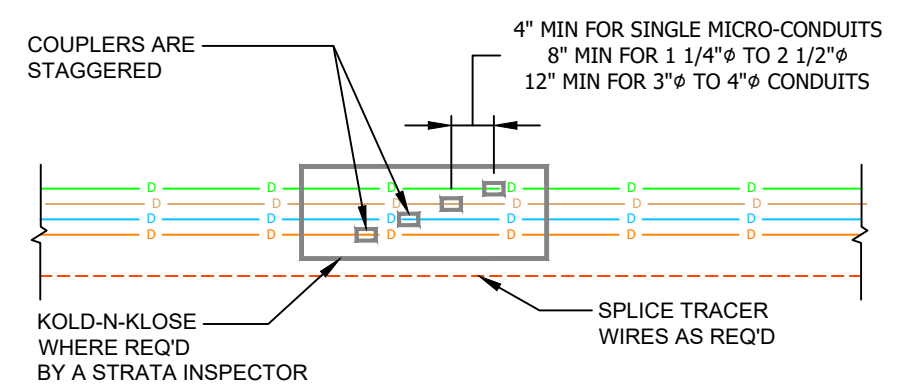

**SINGLE MICRO-CONDUIT OR CONDUIT COUPLE DETAIL**

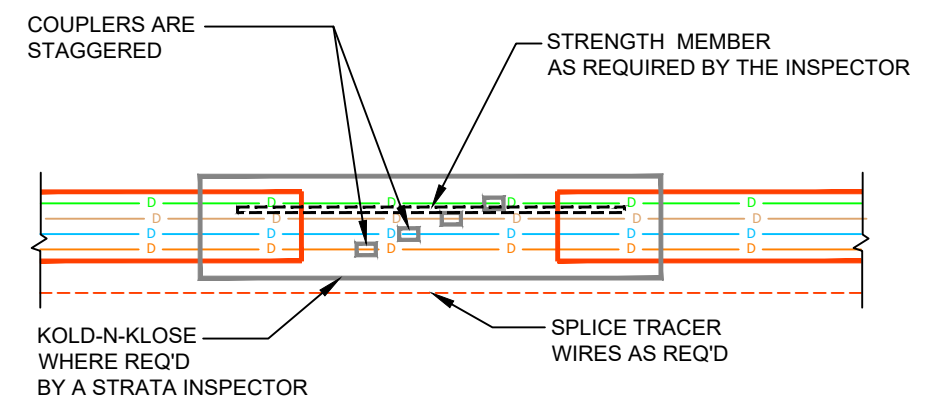

**4 WAY/ 7 WAY FUTURE PATH MICRODUCT CONDUIT COUPLE DETAIL**

**CONDUIT COUPLE DETAILS**

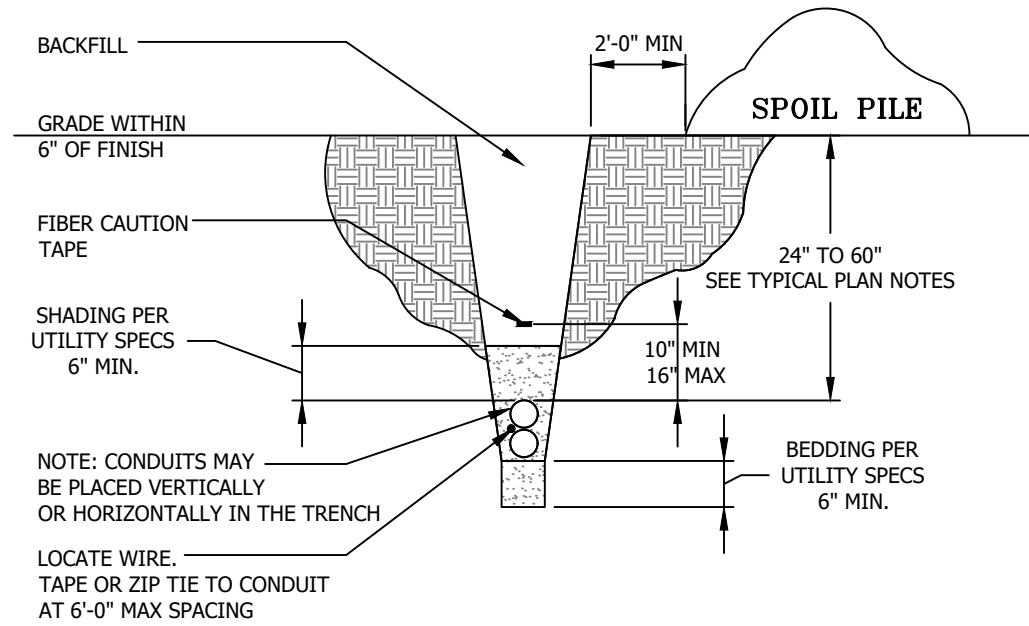

### TYPICAL TRENCH DETAIL

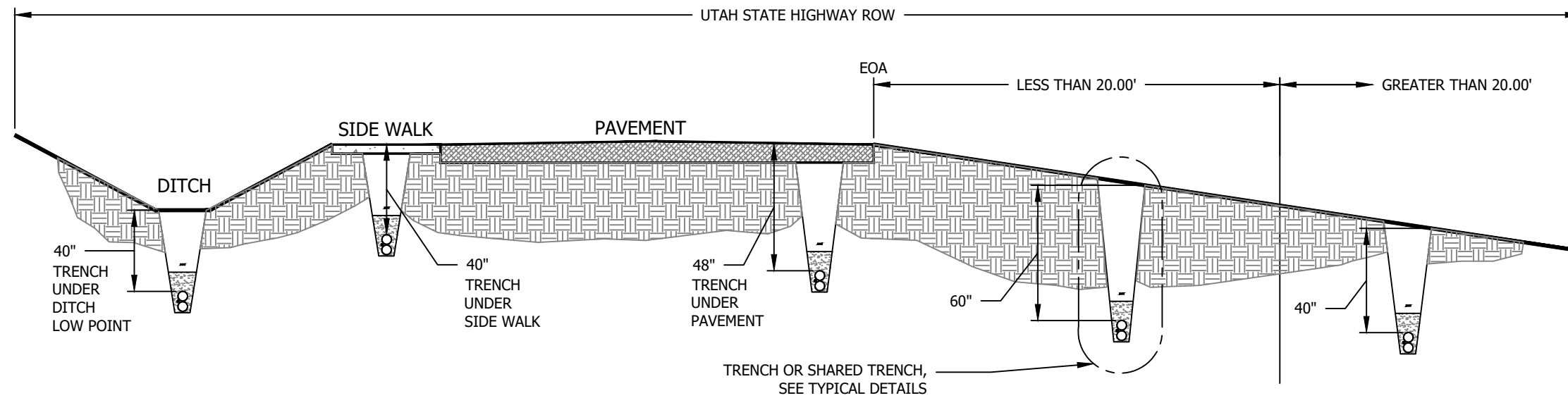

### STATE HIGHWAY R.O.W. TRENCH DETAIL

**NOTES:**

1. ALL FIBER, MESSENGER WIRE, CONDUIT AND OTHER PLACED UTILITIES ON LEHI POWER POLES MUST BE PLACED 40" MIN BELOW ALL POWER LINES, NEUTRALS, AND WEATHER HEADS WITH LOOPS AND MAINTAIN MIN GROUND CLEARANCES AS INDICATED IN THE TYPICAL PLAN NOTES. IF MINIMUM GROUND CLEARANCE AND MINIMUM CLEARANCE TO POWER OR OTHER UTILITIES IS NOT ACHIEVABLE, NOTIFY THE STRATA INSPECTOR IMMEDIATELY.
2. WHEN POLES CONTAIN EXISTING POWER STANDOFFS, ATTACH NEW TELECOMMUNICATION RISERS TO EXISTING STANDOFFS WHERE POSSIBLE. RISERS ON THE INSIDE OF EXISTING POWER STANDOFFS ALLOW FOR 5" MIN. OF SEPARATION BETWEEN THE RISER AND POLE. WHEN EXISTING POWER STANDOFFS DO NOT CONTAIN ENOUGH ROOM TO ALLOW FOR NEW FIBER RISER(S), CONTACT THE LEHI CITY INSPECTOR FOR INSTRUCTIONS ON PLACING NEW FIBER RISER AND OR NEW STANDOFFS.
3. PLACE NEW STANDOFFS AT POLE QUARTERS. ALL STANDOFF HARDWARE TO MATCH LEHI POWER HARDWARE. FOR POLES WITH EXISTING POWER STANDOFFS AND NEW STRATA STANDOFFS ARE PLACED, NEW VERTICAL STANDOFF SPACING SHALL MATCH THE EXISTING VERTICAL POWER STANDOFF SPACING.
4. DETAIL IS REPRESENTATIVE OF TYPICAL FIELD CONDITIONS. ACTUAL CONDITIONS MAY VARY AND ARE SUSCEPTIBLE TO ALTERATIONS AS WARRANTED BY STRATA NETWORKS FIELD INSPECTORS.

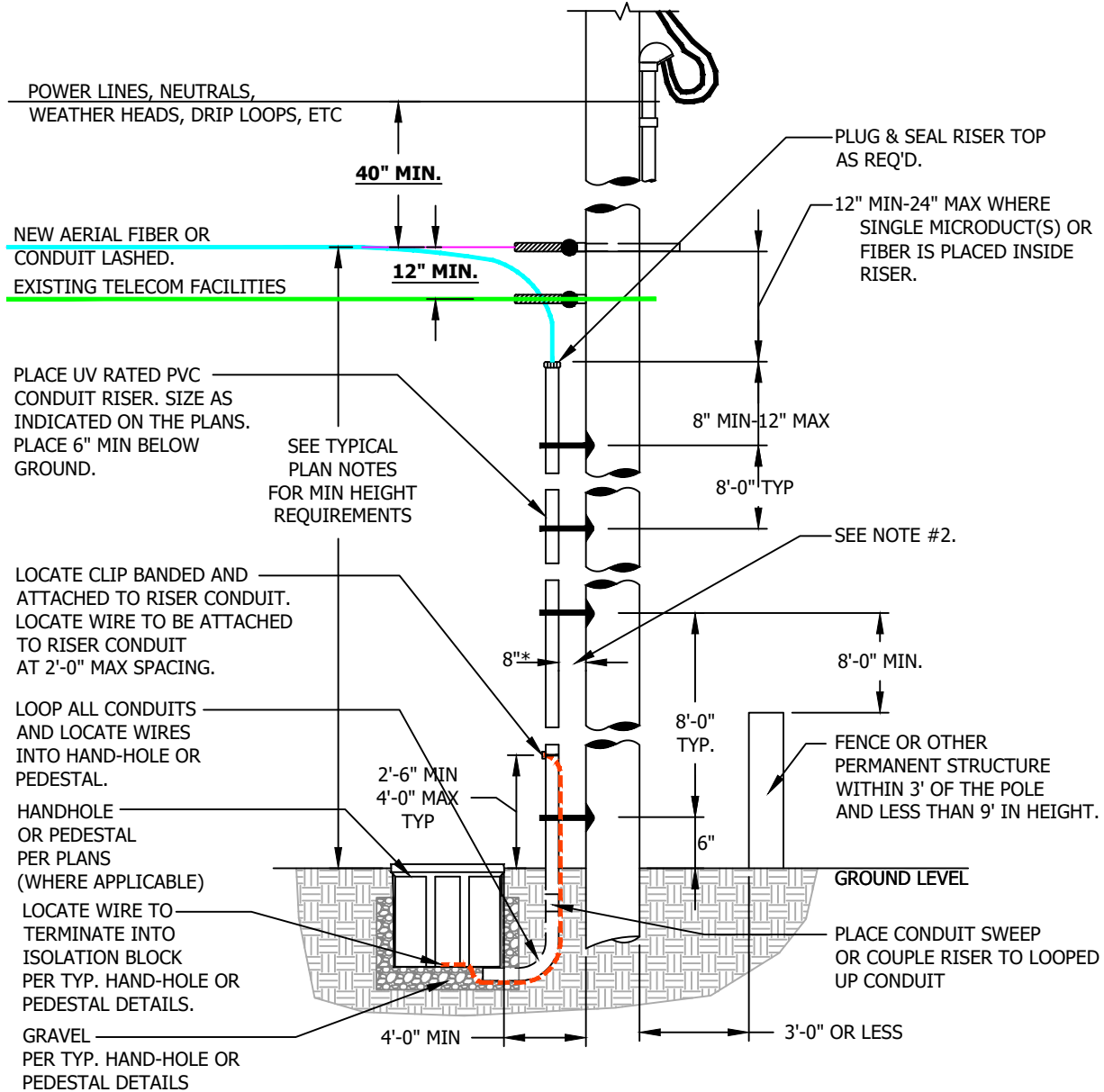

**TYPICAL RISER DETAIL ON SHARED POLE**

**NOTES:**

1. ALL FIBER, MESSENGER WIRE, CONDUIT AND OTHER PLACED UTILITIES ON LEHI POWER POLES MUST BE PLACED 40" MIN BELOW ALL POWER LINES, NEUTRALS, AND WEATHER HEADS WITH LOOPS AND MAINTAIN MIN GROUND CLEARANCES AS INDICATED IN THE TYPICAL PLAN NOTES. IF MINIMUM GROUND CLEARANCE AND MINIMUM CLEARANCE TO POWER OR OTHER UTILITIES IS NOT ACHIEVABLE, NOTIFY THE STRATA INSPECTOR IMMEDIATELY.
2. PER NESC SECTION 235C1, A 12" MIN. SEPARATION BETWEEN POWER AND TELECOMMUNICATION FACILITIES CAN OCCUR WHERE AN INSULATED AERIAL POWER SERVICE WIRE DIPS THE SERVING POLE AND AN AERIAL TELECOMMUNICATION SERVICE DROP CABLE DIPS THE SAME POLE AS TO TRANSITION FROM AERIAL TO BURIED. BOTH POWER AND TELECOMMUNICATION SERVICES MUST ALSO SERVE THE SAME STRUCTURE. MULTIPLE SERVICE DROPS, SERVING MORE THAN ONE CUSTOMER, CANNOT BE SERVED OFF THE SERVICE POLE. ALL OTHER CONDITIONS MUST MEET 40" OF CLEARANCE BETWEEN FACILITIES AS INDICATED ABOVE.
3. PLACE NEW DROP CONDUITS AT POLE QUARTERS. BUNDLE DROP CONDUITS TOGETHER WHERE POSSIBLE. 3 OR MORE NEW SIMULTANEOUSLY PLACED DROPS ON A SHARED POLE SHOULD BE PLACED INSIDE A 2"-3" PVC RISER WITH STANDOFFS. WHERE EXISTING RISERS AND STANDOFFS ARE LOCATED, A NEW RISER SHOULD BE PLACED OR THE DROP CABLE SHOULD BE PLACED INSIDE AN EXISTING FIBER RISER. SEE TYPICAL RISER DETAIL ON SHARED POLE FOR ADDITIONAL REQUIREMENTS ON RISERS.
4. DETAIL IS REPRESENTATIVE OF TYPICAL FIELD CONDITIONS. ACTUAL CONDITIONS MAY VARY AND ARE SUSCEPTIBLE TO ALTERATIONS AS WARRANTED BY STRATA NETWORKS FIELD INSPECTORS.

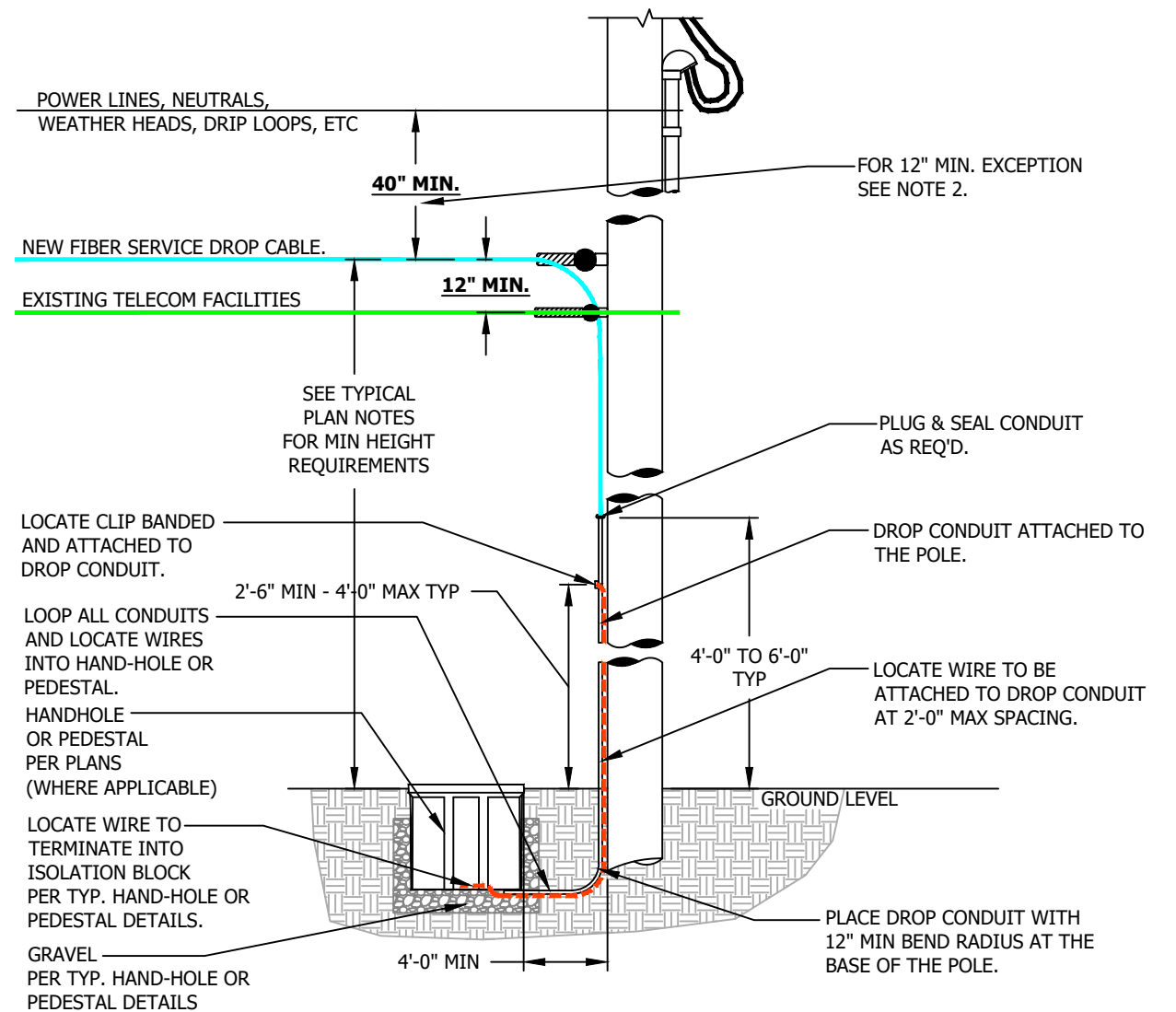

**TYPICAL DROP CONDUIT POLE ATTACHMENT**